

The screenshot shows a software window titled "Scegli" with a Peugeot logo on the left. A list of car manufacturers includes Peugeot, which is highlighted. On the right, fields for car details are filled: "Nome autoveicolo: 106 Typ 2 [2\_106]", "Modello: Bagagliera 3 porte A", "Anno di: 96/04", "Key-No.: 3003781", "Lunghezza totale: 3678", "Larghezza: 1588", "Interasse: 2385", and "Altezza totale:". A color selection bar is visible below the fields. At the bottom, a toolbar contains icons for various file formats: CDR, FS, SCV, CDL, PLT, JOB, AI, EPS, and ES.

- 1) individuare il produttore
- 2) scegliere il modello
- 3) selezionare il colore
- 4) cliccare sul simbolo del software per aprire la vettura nel programma preferito in scala 1:20



# Hard&Software Service Schönweger

## PRINT & CUT DIVISION

I-39012 MERANO Via Bersaglio 19D  
I-39012 MERANO Schießstandstr. 19D  
Tel. 0473 207007 Fax 0473 22 22 31  
e-mail: info@plott.it http:// www.plott.it  
MwSt.Nr.-PI. 01687160216 SteuerNr. cod.fisc. SCHMHL74E01F132K

The screenshot displays the CorelDRAW 10 software interface. The main workspace shows a technical drawing of a car with four views: a top view, a left side view, a right side view, and a rear view. The drawing is centered on a white background. The interface includes a menu bar at the top with options like Datei, Bearbeiten, Ansicht, Layout, Anordnen, Effekte, Bittmaps, Text, Extras, Fenster, and Hilfe. A toolbar is located below the menu bar, containing various drawing and editing tools. A ruler is visible at the top and right of the workspace, showing measurements in millimeters. The status bar at the bottom provides information about the current drawing, including the file name 'CorelDRAW 10 - [C:\pkw\ford\Focus\_ST.CDR]', the current page 'Seite 1', and various drawing parameters such as units (Millimeter), zoom level (45%), and dimensions.



# Hard&Software Service Schönweger

PRINT & CUT DIVISION

I-39012 MERANO Via Bersaglio 19D  
I-39012 MERANO Schießstandstr. 19D  
Tel. 0473 207007 Fax 0473 22 22 31  
e-mail: info@plott.it [http:// www.plott.it](http://www.plott.it)  
MwSt.Nr.-Pl. 01687160216 SteuerNr. cod.fisc. SCHMHL74E01F132K

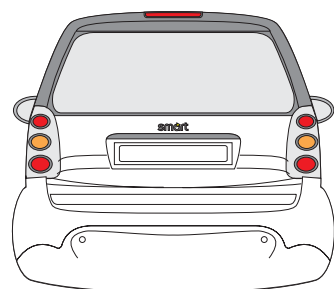
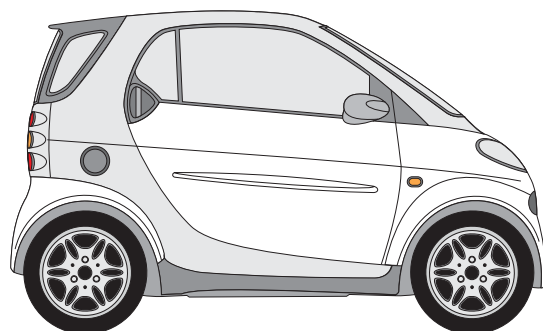
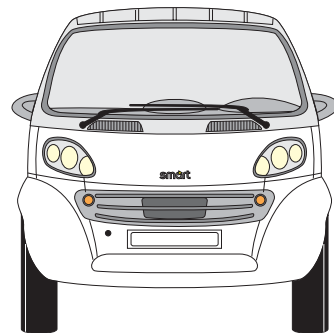
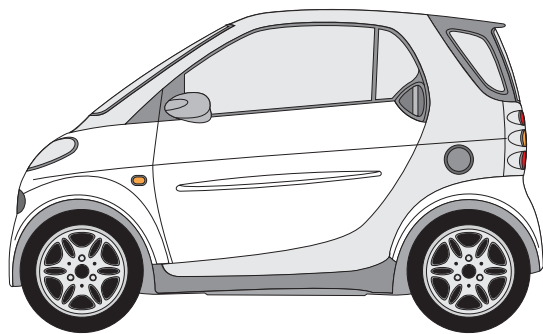
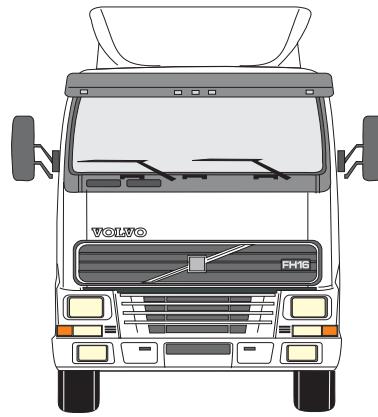
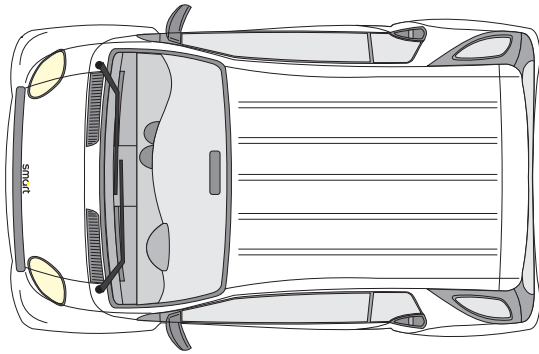
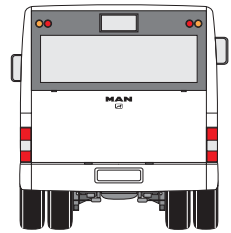
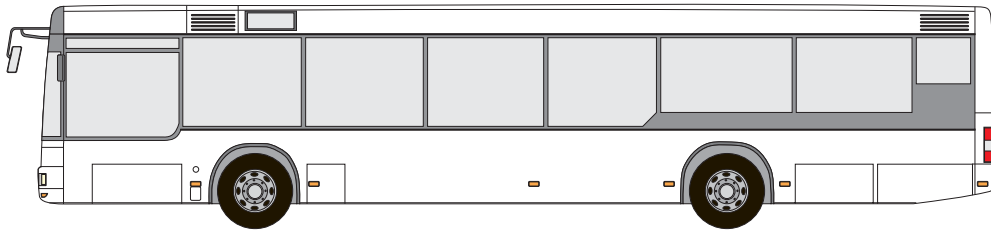
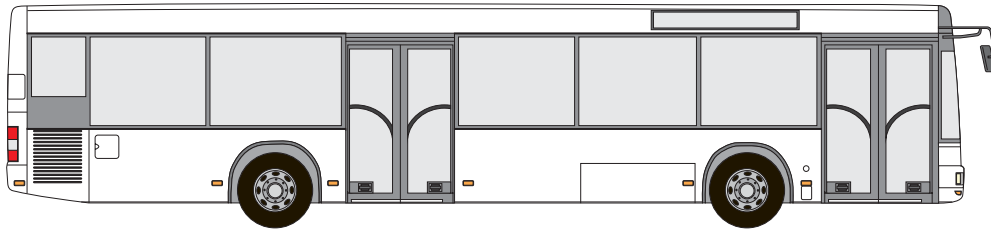

## Catalogo cartaceo con l'indicazione delle misure

